

THESE DRAWINGS PROVIDE A GENERIC OVERVIEW OF THE INSTALLATION. THEY ARE NOT PROJECT SPECIFIC OR REFLECT ANY CUSTOMIZATION UNLESS NOTED. PLEASE CONTACT VORTEX AQUATIC STRUCTURES INTERNATIONAL FOR MORE DETAILS.

PLAN VIEW

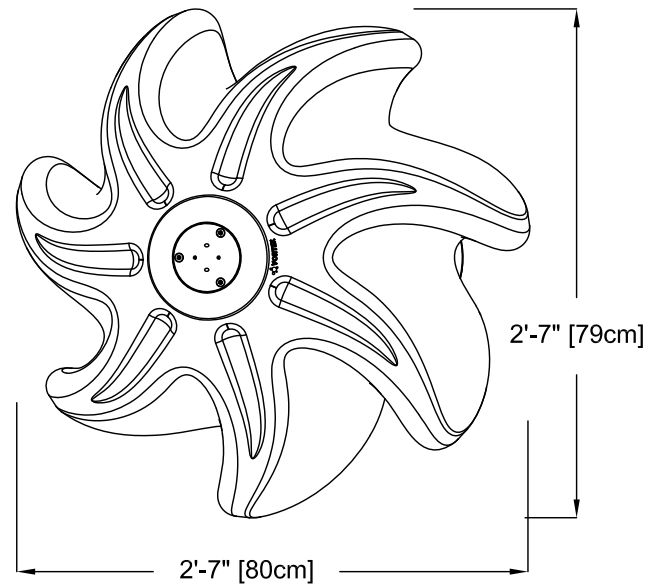

FRONT ELEVATION VIEW

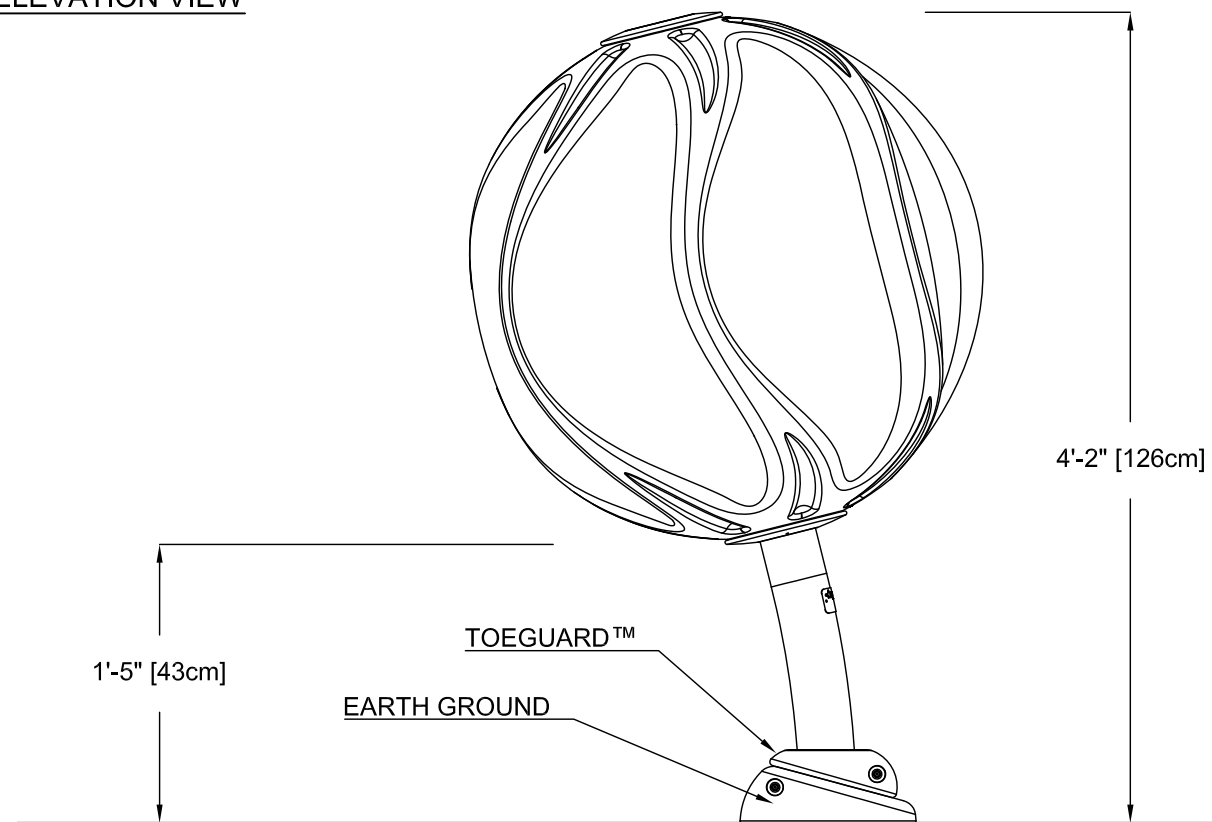

SIDE ELEVATION VIEW



PRODUCT NAME: HELIO No.2

PRODUCT NUMBER: 7237.2XXXX

DATE: 10/04/2017

SHEET NO: 1/1

11"x17" SHEET SIZE

