

WATER JOURNEY™ | MODELS & COMPONENTS

SEPTEMBER 2020



VORTEX-INTL.COM • INFO@VORTEX-INTL.COM
1.877.586.7839 (free USA/CANADA)
+1.514.694.3868 (INTERNATIONAL)

WATER JOURNEY™ | TABLE OF CONTENTS

| | |
|---------------------------|-----------|
| LABYRINTH OVERVIEW | 3 |
| Labyrinth dimensions | 4 |
| Labyrinth fonctionnalité | 5 |
| RACE OVERVIEW | 6 |
| Race dimensions | 7 |
| Race functionality | 8 |
| TIDE POOL OVERVIEW | 9 |
| Tide Pool dimensions | 10 |
| Tide Pool fonctionnalité | 11 |
| COMPONENTS | 12 |
| INSTALLATION | 15 |

WATER JOURNEY™ | LABYRINTH OVERVIEW

Sluices

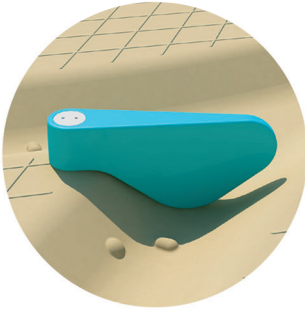

Watermills



Flood plain

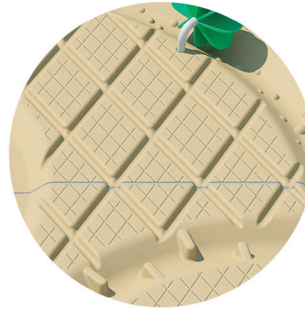

Creek

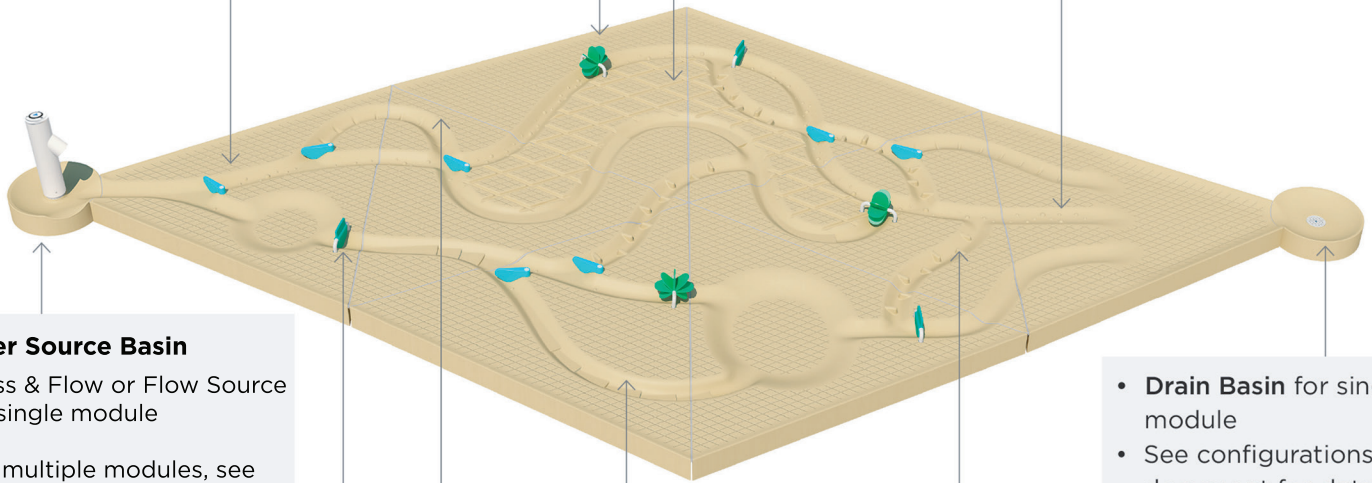
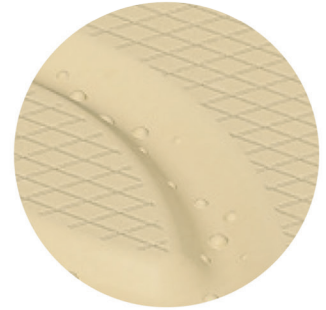

Water Source Basin

- Press & Flow or Flow Source for single module
- For multiple modules, see configurations document.

- **Drain Basin** for single module
- See configurations document for details

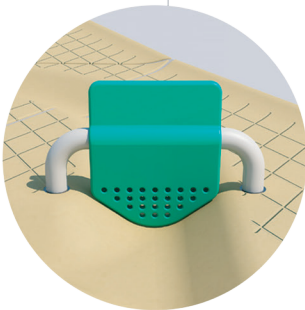

Strainers

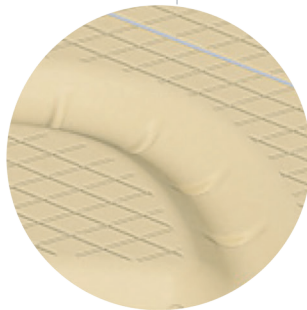

Ripples

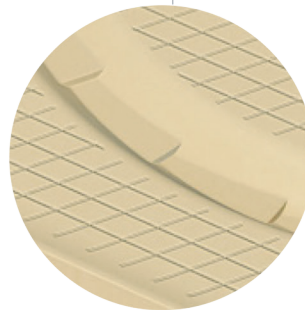

Cascades



Turbulences

WATER JOURNEY™ | LABYRINTH DIMENSIONS

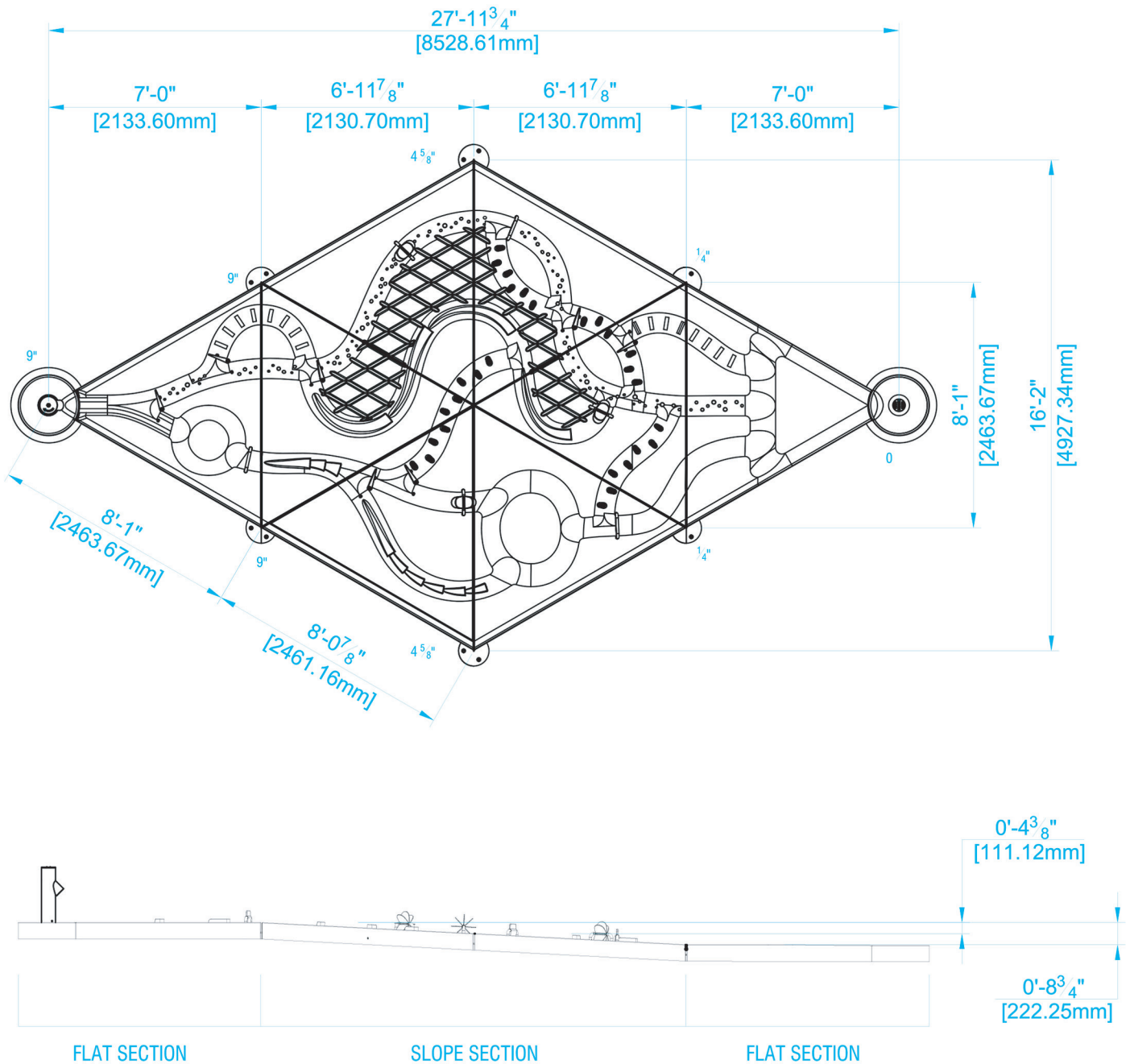

PLAY VALUE

Intertwining channels of water where players control props to manipulate water flow.

INTERACTION

1. Users can interact with three different props to manipulate water flow:
 - Sluices to alter the direction and deviate water into different channels
 - Strainers raise water without overflowing. Pushing down holds the water, lifting up releases the water.
 - Watermills are propelled by water. By holding the pals, one can alter water flow.
2. Beds shaped into concrete are disseminated into the channels. These also affect water flow. There are 5 types of beds:
 - Creek
 - Turbulences
 - Slow Cascades
 - Ripples
 - Fast Cascades
3. Flood plains are used to disperse overflowing water.

COMPONENTS

- 8x Glass Fiber Reinforced Concrete triangles, colour: Yellow pantone Pantone 7402 U
- 9x Leveling support disks made of steel, 2x flat, 7x 3° angled
- 7x Sluices
- 3x Strainers
- 3x Watermills

Also needed:

- Activator signal
- Controller

SPECIFICATION

Single module configuration:

- Labyrinth, yellow (7120)
- Water Source : Press & Flow (7138) or Flow Source (7139) Specify Input connector, yellow (22900.1768)
- Drain Basin (7126): Specify Output Connector, yellow (22900.1769)

Water line requirements:

- Water Source: 1 line
 - Labyrinth: 0 line
- See configurations document for details

Multiple module configurations:

Electrical requirements:

Input on the controller

- Press & Flow : 0
- Flow Source : 0
- Labyrinth: 0

Output from the controller

- Press & Flow : 1
- Flow Source : 0
- Labyrinth: 0

GPM

- Water Source: 7-8 gpm (27-30 lpm)
- Labyrinth: 0 gpm (0 lpm)

NOTE: Refer to install manual for more detailed specification

WATER JOURNEY™ | RACE OVERVIEW

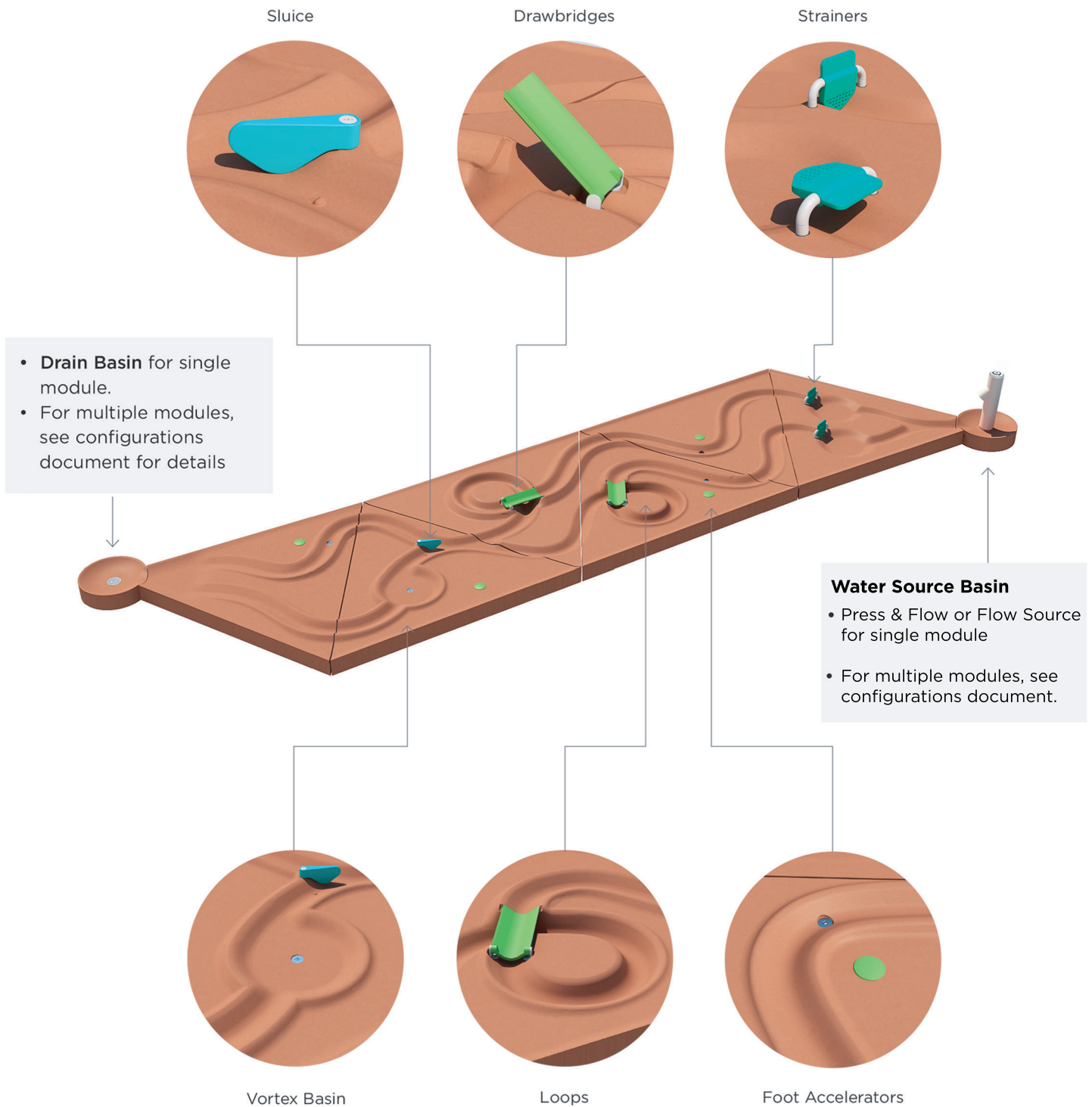

WATER JOURNEY™ | RACE DIMENSIONS

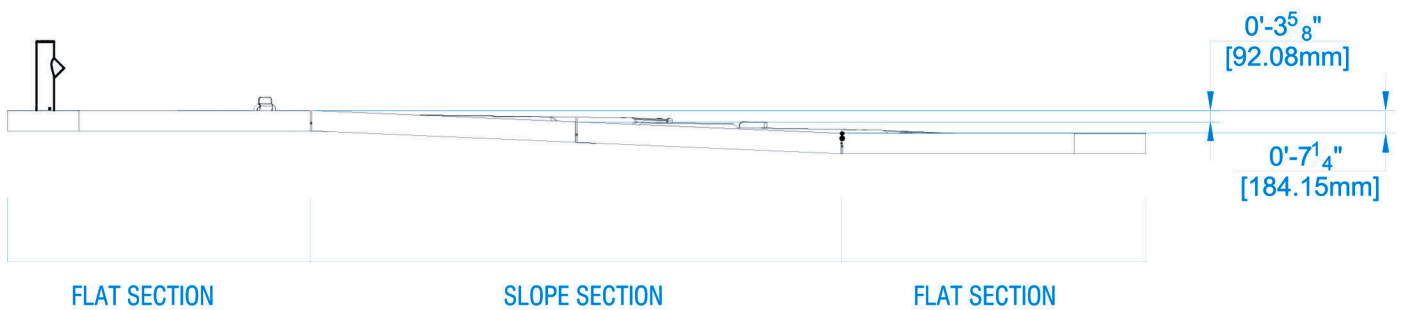
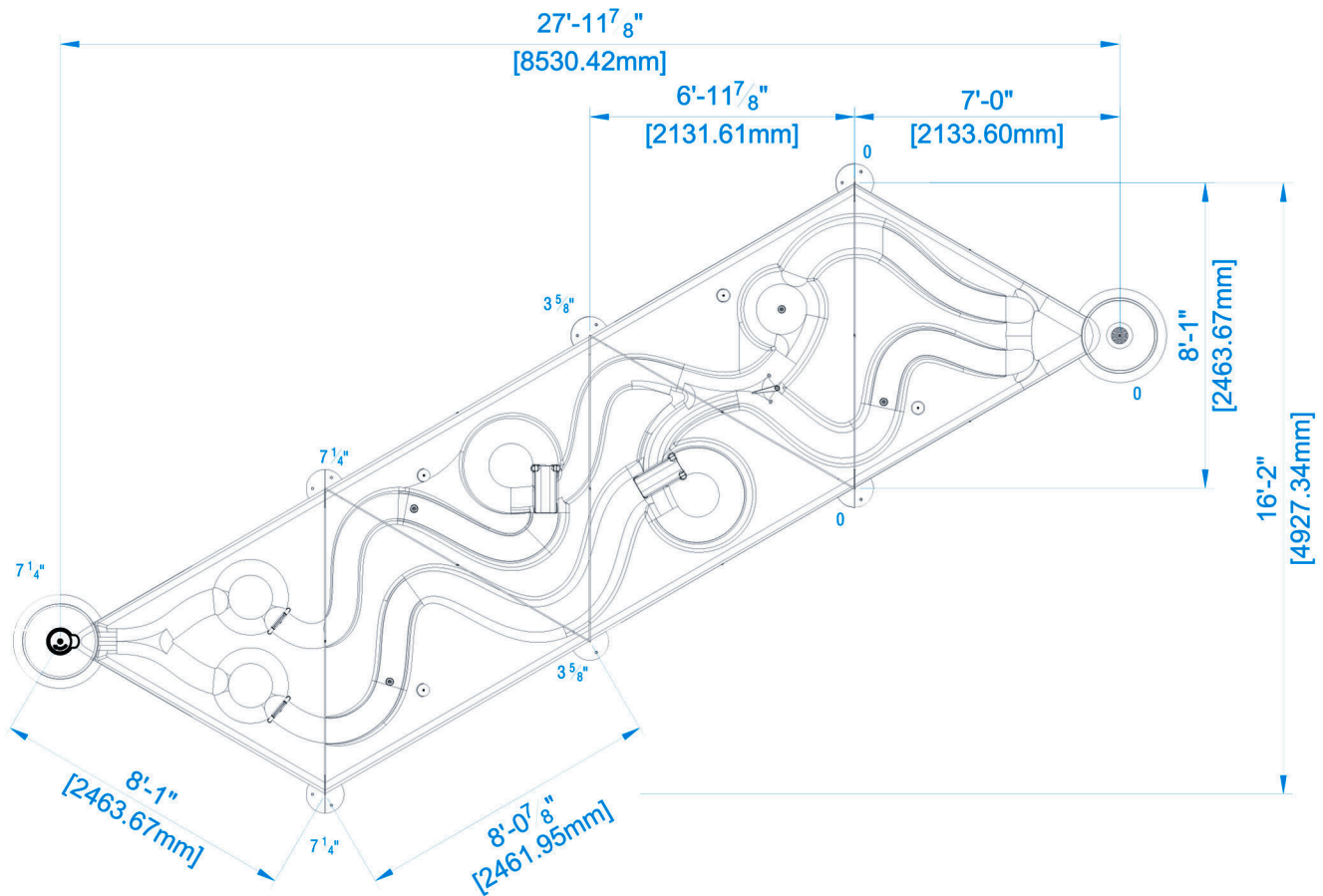

PLAY VALUE

Race challenges players to compete on two channel tracks as they move a floating object from a start pool all the way to the final drain. Leaves, floating toys or water itself can be used to test one's dexterity and strategy.

INTERACTION

The race is made of 2 tracks. These tracks offer different opportunities to be strategic and make critical decisions for your race:

1. Water pump releases water into both tracks
2. Water from the pump gets collected into 2 pools, one for each track
3. Players use a strainer to release the water and get started
4. Use one of the 4 foot accelerators along the way to accelerate the floating objects in the water. These foot pumps release water into the channels to accelerate its flow
5. The loop has a drawbridge. Put it down to let your floating object pass and back up at the right moment to continue its course
6. The two tracks cross paths two third of the way from the beginning to spice things up
7. The final sections are different so players can choose or experience different final sprints
8. The first one in the end pool wins!

COMPONENTS

- 6x Glass Fiber Reinforced Concrete triangles, colour: Red Pantone 164 U
- 8x leveling support disks made of stainless steel, 2x flat, 6x 2,5° angled
- 1x Sluice
- 2x Strainers
- 2x Drawbridges
- 4x Foot pumps (4 x activators + 4 jets)

Also needed:

- Activator signal
- Controller

SPECIFICATION

Single module configuration:

- Race, red (7121)
- Water Source: Press & Flow (7138) or Flow Source (7139), Specify Input Connector, red (22900.1794)
- Drain Basin (7126): Specify Output Connector, red (22900.1795)

Water line requirements:

- Water Source : 1 line
- Race: 1 line for all 4 foot pump activators

Electrical requirements:

- Input on the controller
- Press & Flow : 0
 - Flow Source : 0
 - Race: 0

Output from the controller:

- Press & Flow : 1
- Flow Source : 0
- Race: 1

Multiple module configurations:

- See configurations document for details

GPM

- Water Source: 7-8 gpm (27-30 lpm)
- Jet Dance: 8-18 gpm (30-68 lpm)

NOTE: Refer to install manual for more detailed specification

WATER JOURNEY™ | TIDE POOL OVERVIEW

Water Source Basin

- Press & Flow or Flow Source for single module
- For multiple modules, see configurations document.

- Drain Basin for single module.
- For multiple modules, see configurations document

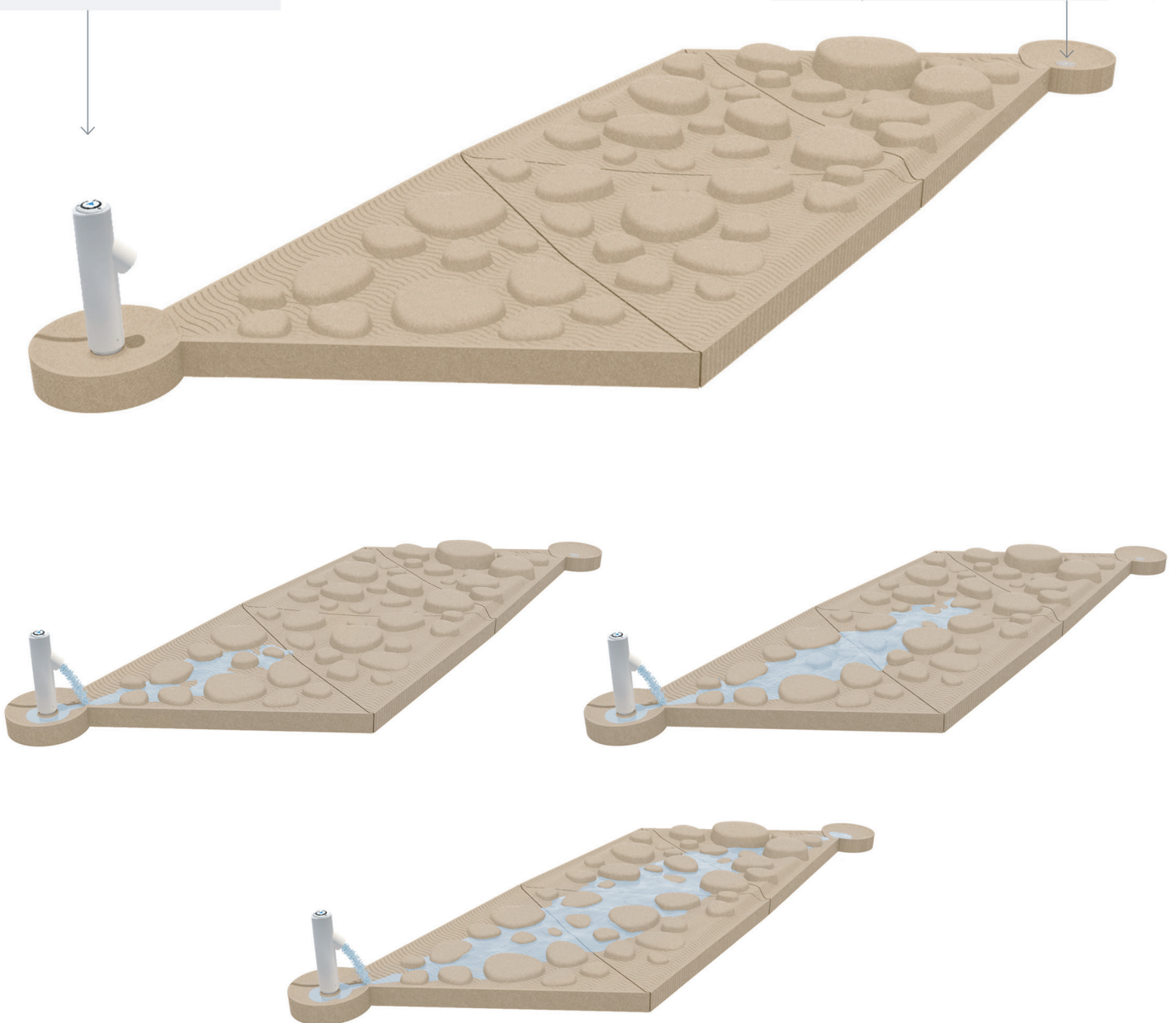

WATER JOURNEY™ | TIDE POOL DIMENSIONS

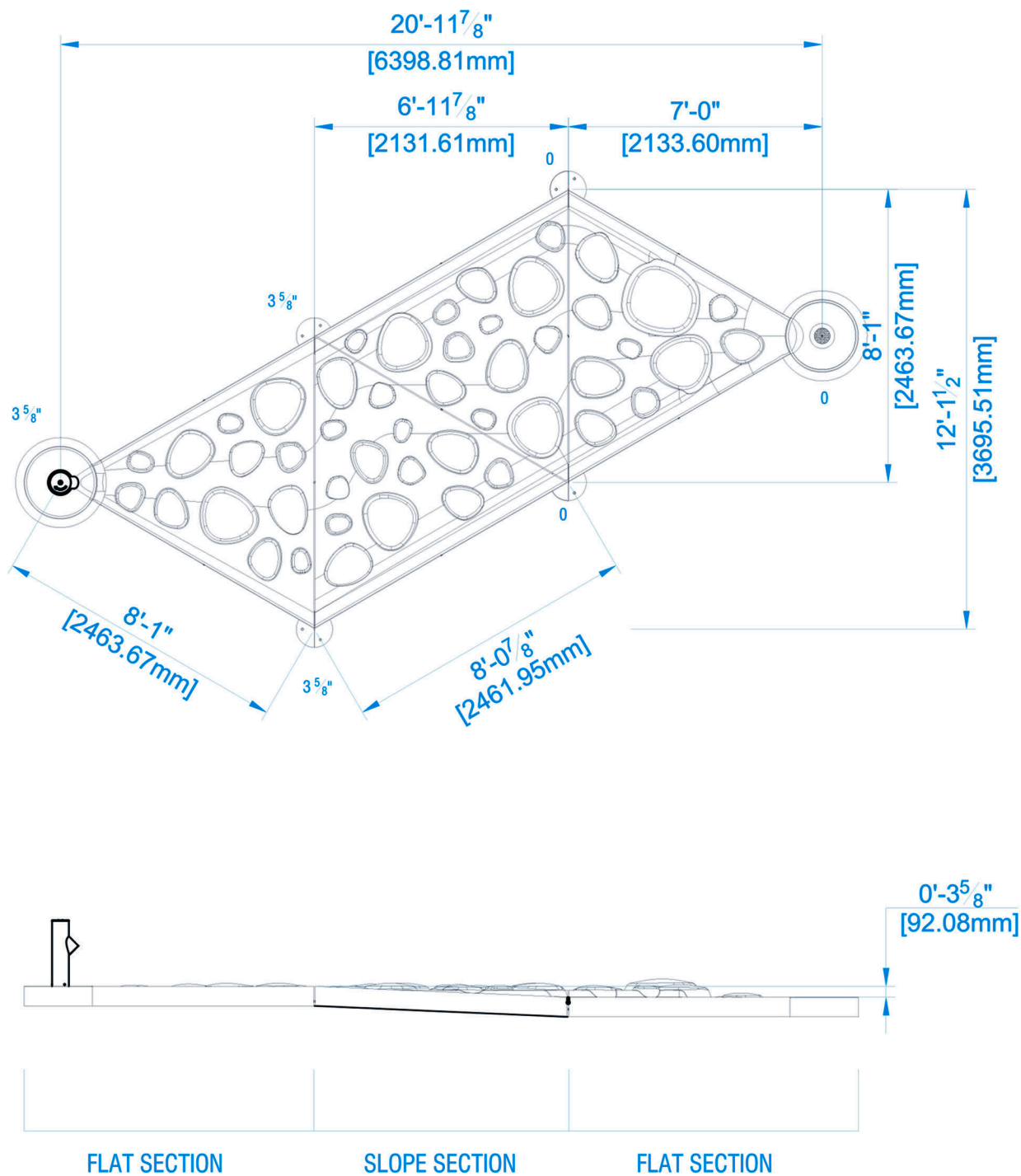

PLAY VALUE

Water flows through a pebbled landscape. Rocks of varying sizes and heights lay in a shallow pool where water collects. Tides go up and down according to the amount of water entering the game module.

INTERACTION

1. As the water level rises, it reveals and conceals different 'families' of elements for users to walk and jump on. A mix of the famous game Twister and skipping rocks.

COMPONENTS

- 4 x Glass Fiber Reinforced Concrete triangles, colour: Beige Pantone 7501 U
- 6x leveling supports disks made of steel, 2x flat, 4x 2,5° angled

Also needed:

- Activator signal
- Controller

SPECIFICATION

- Tide Pool, beige (7122)
- Water Source : Press & Flow Basin (7138) or Flow Source Basin (7139): Specify Input Connector, beige (22900.1800)
- Drain Basin (7126): Specify Output Connector, beige (22900.1801)

Water line requirements:

- Water Source : 1 line
- Tide Pool: 0 line

Electrical requirements:

Input to the controller:

- Press & Flow: 0, Flow Source: 0
- Tide Pool: 0

Output from the controller:

- Press & Flow: 1, Flow Source: 0
- Tide Pool: 0

Multiple module configurations:

- See configurations document for details

GPM

- Water Source : 7-8 gpm (27-30 lpm)
- Tide Pool: 0 gpm (0 lpm)

NOTE: Refer to install manual for more detailed specification

SLICE

Pivots to steer the water flow through the channels. Assembled on the GFRC triangles with UHMW bushings, steel embedded anchors and tamper resistant screws.

Body:
Polyurethane > Blue, Pantone 319 U

Hinge:
Powder coated stainless steel > White , RAL 9003

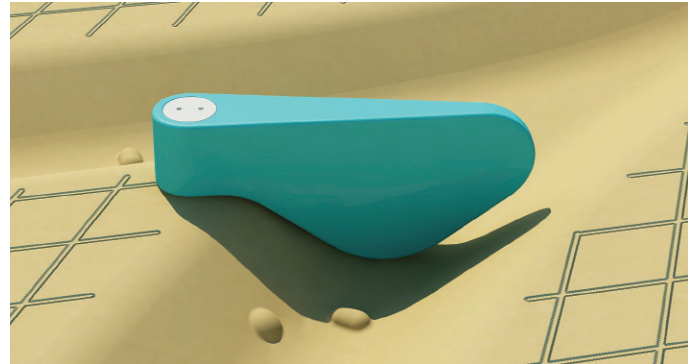

WATERMILL

Water propels the Watermill. The rotation renders the speed of the flow. User can manipulate to speed up or interrupt the flow. Assembled on the GFRC triangles with embedded anchors and tamper resistant screws.

Body:
Polyurethane > Green, Pantone 7487 U

Shoulders:
Powder coated stainless steel > White , RAL 9003

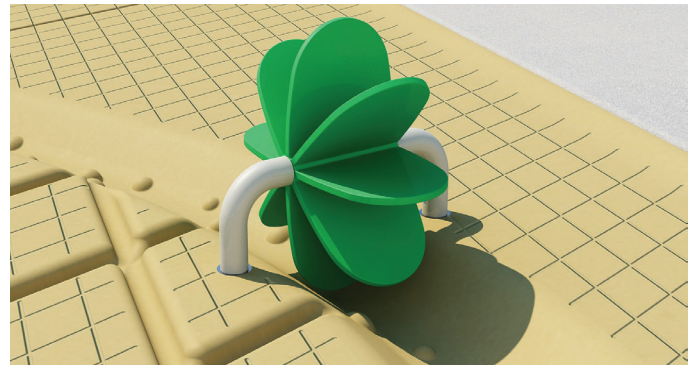

STRAINER

Transforms water flow, raises water without overflowing. Pushing down holds the water, lifting up releases the water. Assembled on the GFRC triangles with embedded anchors and tamper resistant screws.

Body:
Polyurethane > Turquoise, Pantone 3275 U

Shoulders:
Powder coated stainless steel > White , RAL 9003

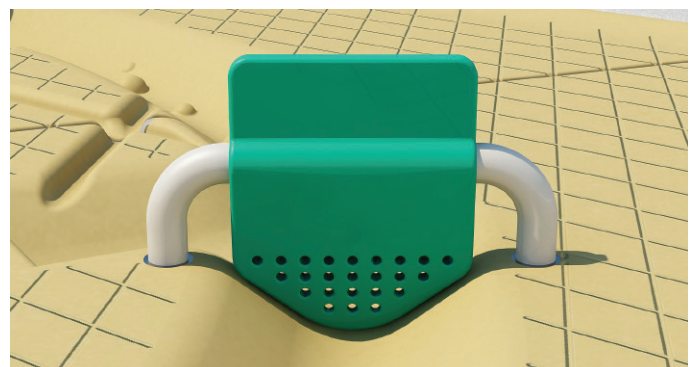

DRAWBRIDGE

If the bridge is down the water flows through it's normal path. If the bridge is up, the water bypasses the loop. Assembled on the GFRC triangles with embedded anchors and tamper resistant screws.

Body:
Polyurethane > Green, Pantone 7487 U

Hinge:
Powder coated stainless steel > White , RAL 9003

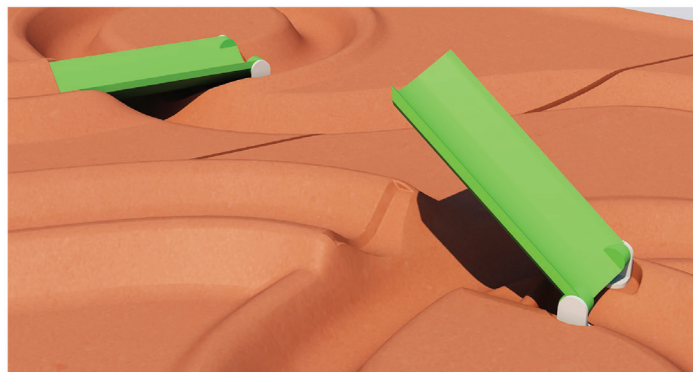

FOOT ACCELERATOR

The user presses the foot activator to inject an extra amount of water into the flow in order to speed it up. Assembled on the GFRC triangles mechanically and sealed with caulking. Required independent 3/4" pipe water feed.

Foot activator:
UHMWPE > Blue

Jet Housing: **Jet Nozzle:**
Stainless steel Brass

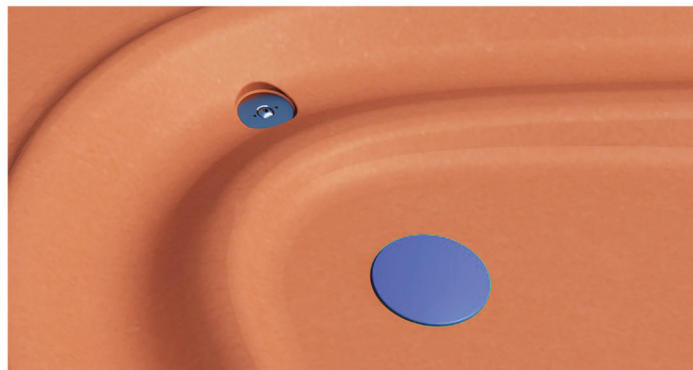

WATER SOURCE

A choice of two water source should release 7-8 gpm (31-36 LPM) of continuous flow of water.

Press & Flow

Press the button to activate water for a period of 4 minutes.

Flow Source

A sequence bell-shaped laminar effect.

Body:
Powder coated stainless steel > White , RAL 9003

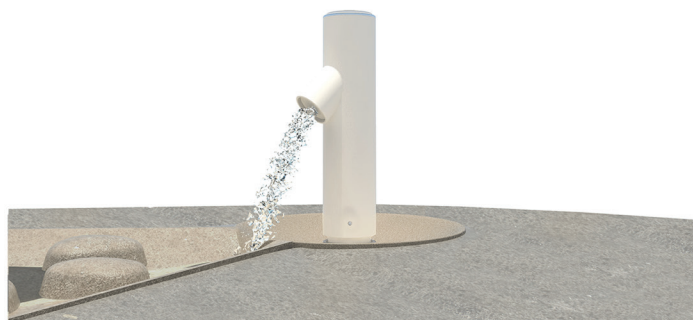

WATER SOURCE

Installed upstream from a module. The specified colour should be the same as the following module

Required 2" pipe drain

Includes:

- Water source with overflow
- Input Basin or Connector Basins (60°A, 60°B, 120° A or 120° B)

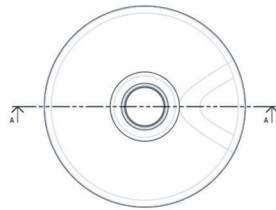

FLOW BASINS

Installed to connect to modules. The specified colour should be the same as the following module

Required 2" pipe drain

Includes:

- Overflow
- Connector Basins (60°A, 60°B, 120° A or 120° B)

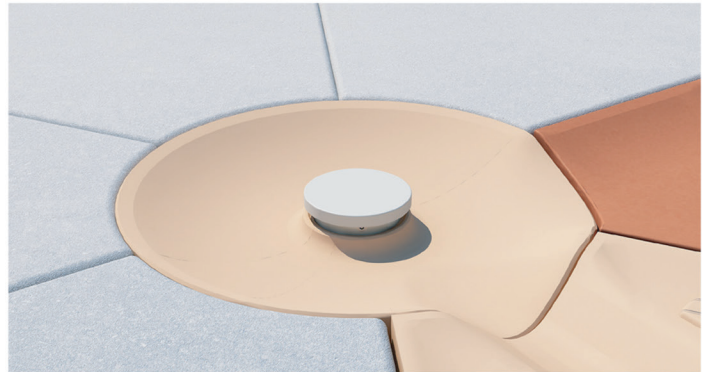
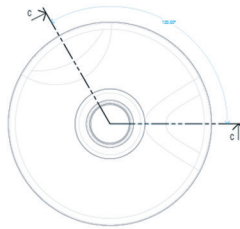

DRAIN BASIN

Installed downstream of a single module or a series of modules. The specified colour should be the same as the preceding module.

Required 2" pipe drain.

Includes:

- Drain
- Grate
- Output Basin

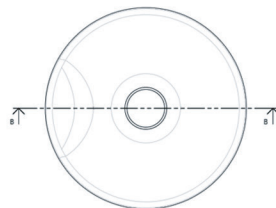

WATER JOURNEY™ | INSTALLATION

STEP 1

Preparing the ground and Installing sonotubes

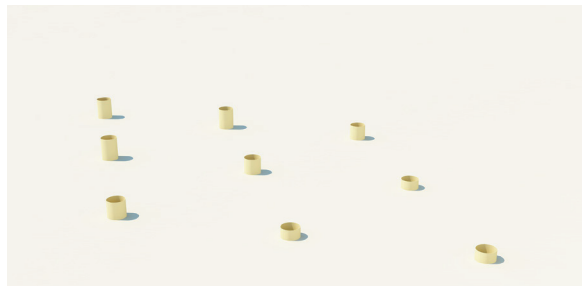

STEP 2

Pouring concrete and assembling the levelling supports

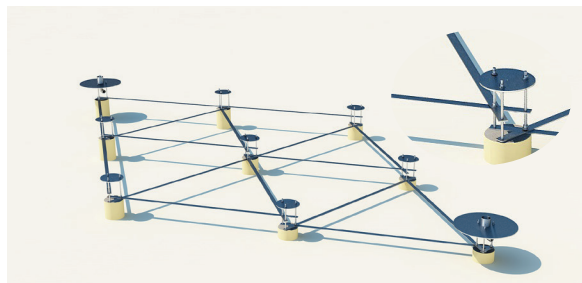

STEP 3

Laying the GFRC Triangles on supports and levelling.

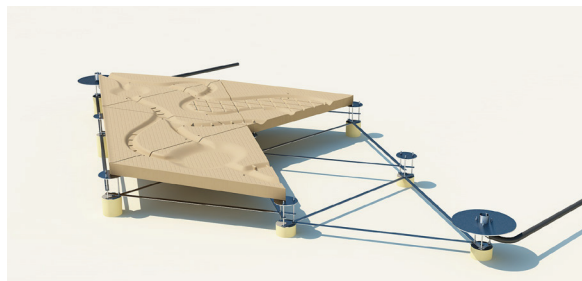

STEP 4

Assembling the props and caulking the joints

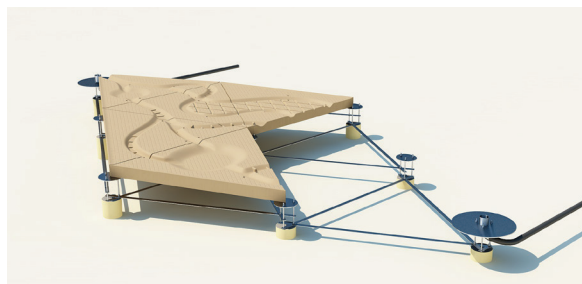

STEP 5

Fill in the surrounding area and build a Buffer / pedestrian zone.

